



Ultra Short Anti Vandal Switch Ø 19mm / Ø 22mm / Ø 25mm

Specifications

Electrical rating: 50mA, 24VDC
Mechanical life: 1000,000 Cycles
Electrical life: 50,000 Cycles
Contact resistance: 50mΩ Max
Insulation resistance: 1000mΩ Min
Dielectric strength: 2.000VAC
Operating / Storage Temperature: -25°C to 55°C
Travel: 0.5mm
Moisture protection: IP67
Actuation force: 4N
Panel thickness: 1-3mm
Mounting nut torque: 5-14Nm

Features & Benefits

- 19, 22 or 25mm diameter panel cutout
- Variety of LED option
- Multiple function options
- Ring illumination available
- IP67 rated

Order Code

Series	Actuator Options	Terminal Options	Function Options	Material Options	Illumination Style Options	LED-Color Options	Illumination Voltage Options	Graphic Options
<input type="checkbox"/> L19U L22U L25U	<input type="checkbox"/> F- Flat	<input type="checkbox"/> NONE-Solder lug(2.0x0.5)	<input type="checkbox"/> M-Momentary 1-1NO	<input type="checkbox"/> S-Stainless steel	<input type="checkbox"/> NONE-Non-illum. R-Ring	<input type="checkbox"/> NONE-Non-illum. W- White R- Red O- Orange G-Green B-Blue Y-Yellow	<input type="checkbox"/> NONE-Non-illum. 1-Base voltage** 3.3V 6V 12V 24V	<input type="checkbox"/> NONE-Non-illum. LE-Laser etched

Notes:

*Base voltage on LEDs:
 1.8V @ 20mA for red, yellow and orange LED colors
 2.8V @ 20mA for blue, green and white LED colors

Dimensions

Ultra Short Anti Vandal Switch $\varnothing 19\text{mm}$

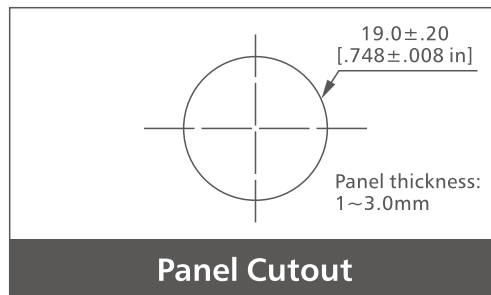
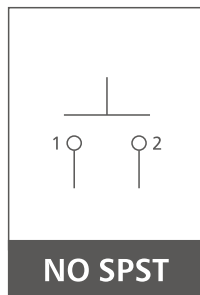
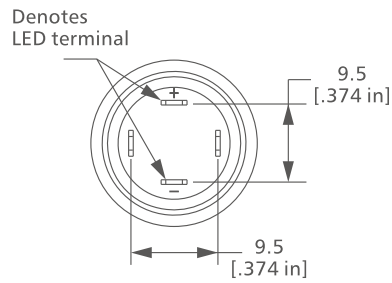
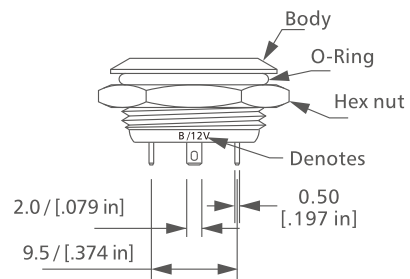
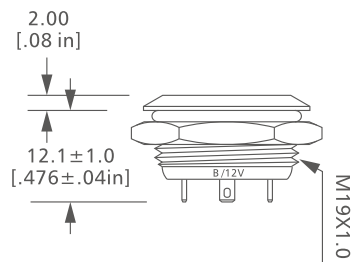
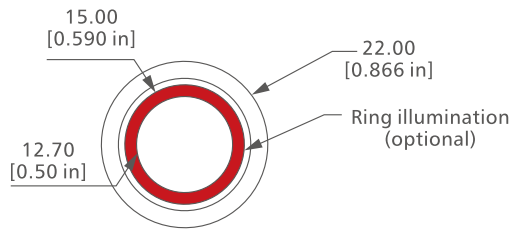

Dimensions

Ultra Short Anti Vandal Switch $\varnothing 22\text{mm}$

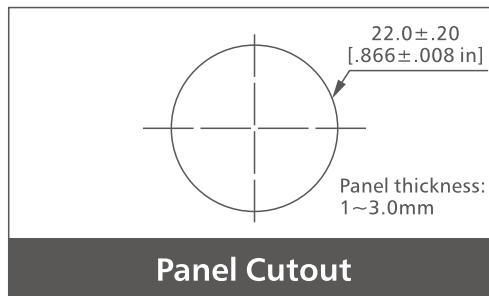
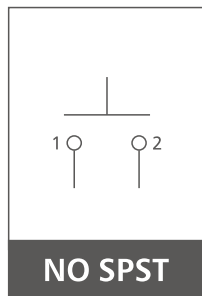
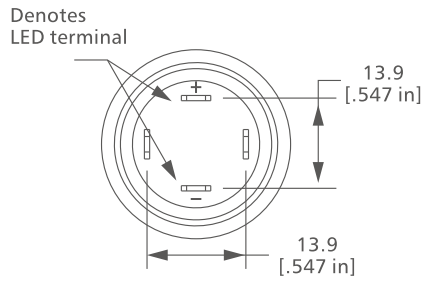
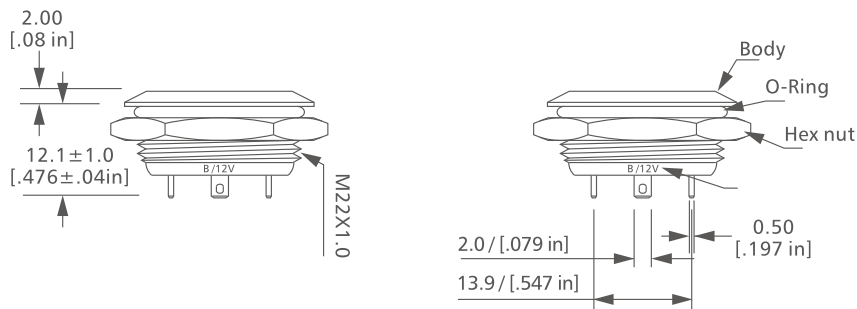
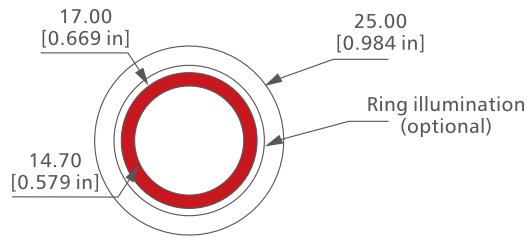

Dimensions

Ultra Short Anti Vandal Switch $\varnothing 25\text{mm}$

