



# Anti Vandal Switch

## Ø 22mm

### Order Code

Series	Actuator Options	Terminal Options	Function Options	Material Options	Graphic Options
<input type="checkbox"/> <input type="checkbox"/>	<input type="checkbox"/>	<input type="checkbox"/>	<input type="checkbox"/>	<input type="checkbox"/> —	<input type="checkbox"/> <input type="checkbox"/> <input type="checkbox"/>
V22	F-Flat H-High B-Domed	P-Solder lug (2.8X0.5) NONE-Screw	<b>Momentary</b> 1-NO	<b>S-Stainless steel</b>	<b>NONE</b> -Non-marking <b>LE</b> -Laser etched

### Description

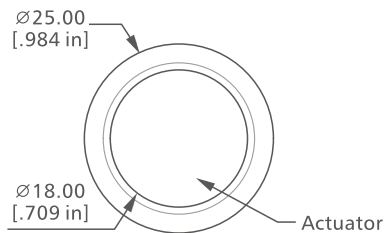

Panel thickness: 1~8mm

### Technical Data

Type	V22-F	V22-B	V22-H
Front Shape	Flat	Domed	High flat
Terminal	Screw / Solder lug (2.8X0.5)		
Max. switch rating	2A 48VDC		
Contact resistance	≤ 50m Ω		
Insulation resistance	≥ 1000m Ω		
Dielectric strength	2000VAC		
Operation temp	-20°C ~ +55°C		
Mechanical life	1,000,000 cycles		
Electrical life	200,000 cycles		
Contact material	Silver alloy		
Torque	5~14Nm		
Operation pressure	Approx. 5.5N		
Protection	IP65 / IK09		
Material			
Actuator	Stainless steel		
Body	Stainless steel		
Base	PBT		

### Actuator Options

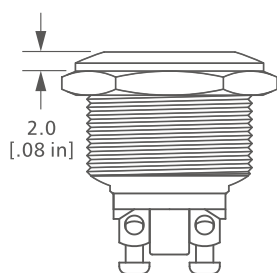

Flat Actuator

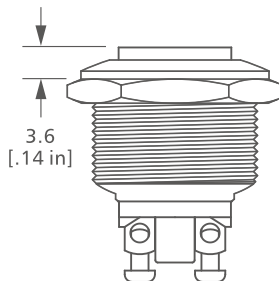

High Actuator

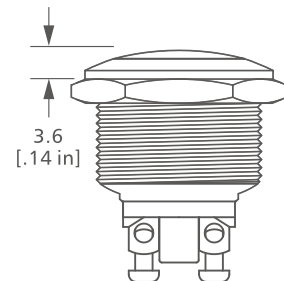

Domed Actuator

## Solder Terminal

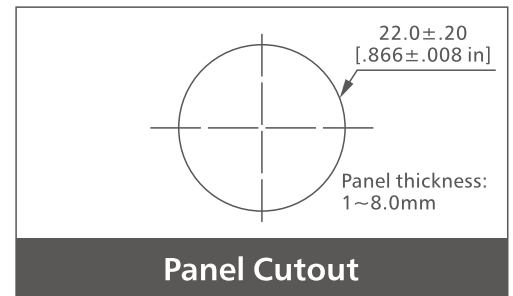
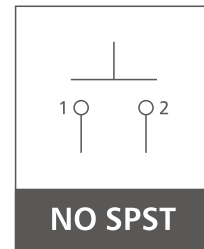
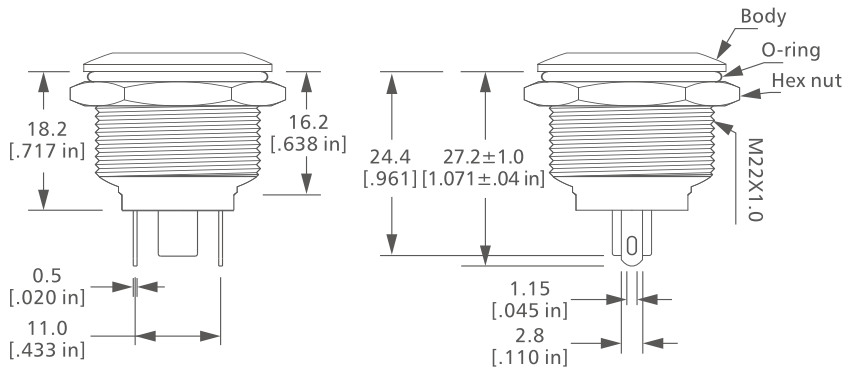

## Screw Terminal

