



Anti Vandal Switch Ø 19mm(Short Body)

Order Code

Series	Actuator Options	Terminal Options	Function Options	Material	Graphic Options
<input type="checkbox"/> <input type="checkbox"/>	<input type="checkbox"/>	<input type="checkbox"/>	<input type="checkbox"/>	<input type="checkbox"/> —	<input type="checkbox"/> <input type="checkbox"/> <input type="checkbox"/>
VS19	F-Flat H-High B-Domed	P-Solder lug (2.8X0.5) NONE-Screw	Momentary 1-NO 2-NC	S-Stainless steel N-Nickel plated brass A-Anodized aluminum	NONE-Non-marking LE-Laser etched

Description

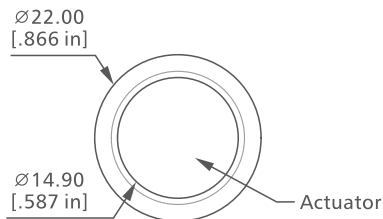

Panel thickness: 1~6mm

Technical Data

Type	VS19-F	VS19-B	VS19-H
Actuator options	Flat	Domed	High
Terminal	Screw / Solder lug (2.8X0.5)		
Max. switch rating	2A 48VDC		
Contact resistance	≤ 50m Ω		
Insulation resistance	≥ 1000m Ω		
Dielectric strength	2000VAC		
Operation temp	-20°C ~ +55°C		
Mechanical life	1,000,000 cycles		
Electrical life	200,000 cycles		
Contact material	Silver alloy		
Torque	5~14Nm		
Operation pressure	Approx. 5N		
Protection	IP65 / IK09		
Material			
Actuator	Stainless steel / Nickel plated brass / Anodized aluminum		
Body	Stainless steel / Nickel plated brass / Anodized aluminum		
Base	PBT		

Actuator Options

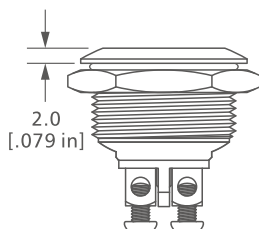

Flat Actuator

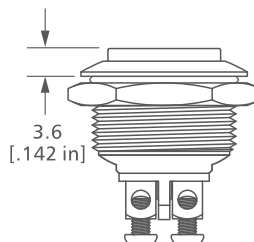

High Actuator

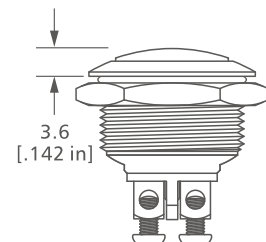

Domed Actuator

Solder Terminal

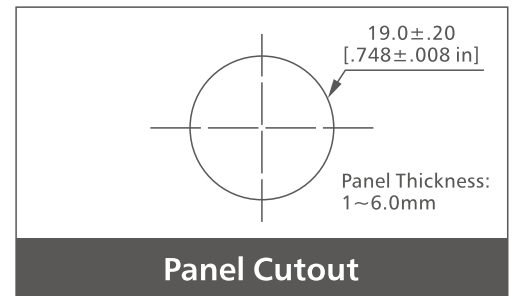
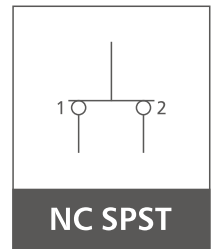
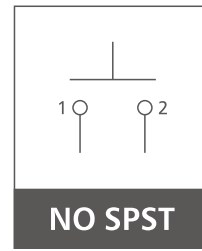
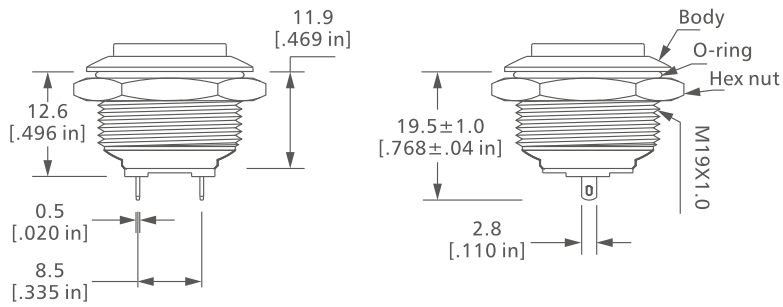

Screw Terminal

